

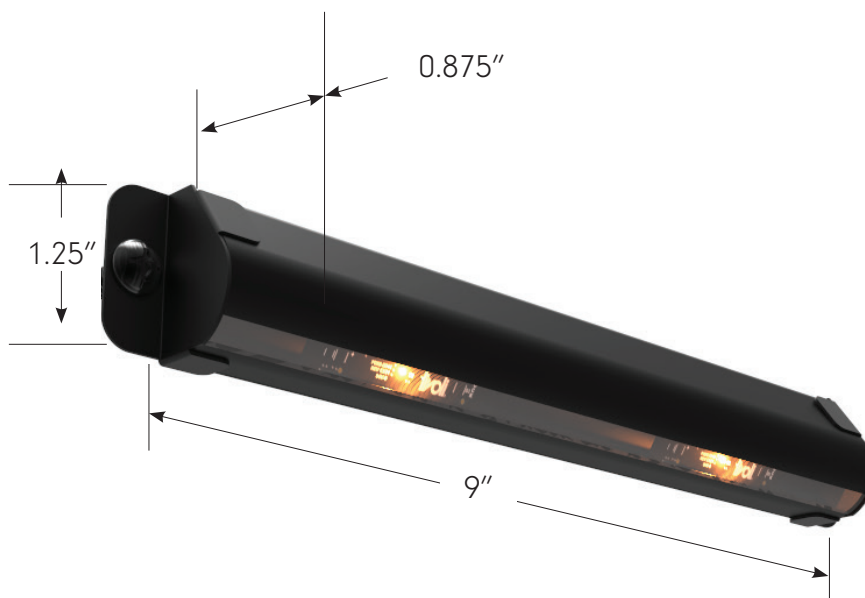

Project: _____ Type: _____

- Compact size 9" x 1.25" x 0.875" hidden light source, tamper resistant seat mounted LED lighting system.
- Individually replaceable LED PCBs easily snap into Titanium modules for easy and economical maintenance.
- 48" super-flex conduit standard for wireway connection.
- Use with Tivoli's patented two-tone bullnose stair nosing and wireway with reflective edge to step delineation to maximize voltage drop.

Dimensions



Ordering Guide

PRODUCT CODE	FEEDPOINT	LED BOTTOM	NUMBER OF LEDS	FINISH
UST				M
UST = Usher Seat Titanium	C = Center R = Right L = Left	19 = 1900K 27 = 2700K 30 = 3000K 35 = 3500K 40 = 4000K AM = Amber RD = Red BL = Blue	02 = Low Brightness 03 = Standard Brightness	M = Matte

Specification

Electrical (based on 3000K Sample)		
LED Brightness	Low	Standard
*Lumens/ft	21	33
*Watts/unit	0.5	0.7
*Lumen/watt	47	
Beam Angle	45°	
CRI	>80/TYP83	
Kelvin Temp	1900K, 2700K, 3000K, 3500K, 4000K (+/- 80K) 3SDCM, Red, Blue, Amber	
Operating Voltage	12V DC	
Dimming	MLV	
Certification and Testing		
Certification	cETLus, ADA, NFPA	
Environment	Damp Location	
Power Supply	Class 2	
Rated Life	75,000 hrs.	
Warranty	5 years	

Mounting Accessories

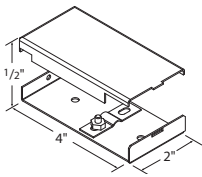

JBOX-LP
Junction box, low profile

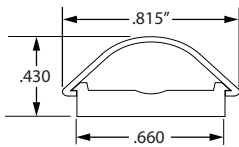

BS-CC-8
Wall wireway, 8' Black Base & Conduit Cover



BSL-PC-1/4
0.25" Flex Conduit, Black

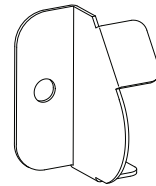

UTT-EC-X
X = L (left), R (right)
End Cap

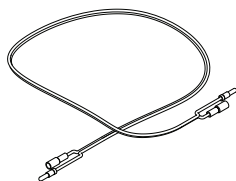

TTJUMPER2
24 inch lead jumper

Replacement Parts

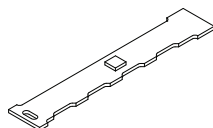

UTT-LED-XX
XX = 19 (1900K), 27 (2700K), 30 (3000K), 35 (3500K), 40 (4000K), AM (amber), BL (blue), RD (red)

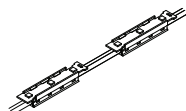

UTT-02-STRAND-XX
XX = 19 (1900K), 27 (2700K), 30 (3000K), 35 (3500K), 40 (4000K), AM (amber), BL (blue), RD (red)
2 Modules per foot replacement strand with LEDS

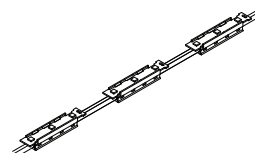

UTT-03-STRAND-XX
XX = 19 (1900K), 27 (2700K), 30 (3000K), 35 (3500K), 40 (4000K), AM (amber), BL (blue), RD (red)
3 Modules per foot replacement strand with LEDS

In-Wall Controls



Touchscreen

TVOQ-1-WH
White



Touchscreen

TVOQ-10-XX-7
XX = BK (Black), WH (White)



Touchscreen

TVOQ-2-BK
Black



Power Supplies

ADNM - NON DIMMING

DESCRIPTION	CAT NO	APPLICATION	PRIMARY VOLTAGE	SECONDARY VOLTAGE	CIRCUIT BREAKERS	MAX LOAD	CIRCUIT CAPACITY
ADNM Series Class 2 Transformer	ADNM-60-1-5-12-D	Indoor / Outdoor	100-277V AC 50/60 HZ	12V DC	1	60W	5A
	ADNM-80-1-5-12-D				1	60W	5A
	ADNM-150-2-5-12-D				2	2x60W	2x5A
	ADNM-240-3-5-12-D				3	3x60W	3x5A
	ADNM-320-4-5-12-D				4	4x60W	4x5A

ADNM - 0-10V DIMMING

DESCRIPTION	CAT NO	APPLICATION	PRIMARY VOLTAGE	SECONDARY VOLTAGE	CIRCUIT BREAKERS	MAX LOAD	CIRCUIT CAPACITY
ADNM Series Class 2 Transformer	ADNM-60-1-5-12-DOT	Indoor / Outdoor	100-277V AC 50/60 HZ	12V DC	1	60W	5A
	ADNM-80-1-5-12-DOT				1	60W	5A
	ADNM-150-2-5-12-DOT				2	2x60W	2x5A
	ADNM-240-3-5-12-DOT				3	3x60W	3x5A
	ADNM-320-4-5-12-DOT				4	4x60W	4x5A

ADNM - DMX SINGLE ADDRESS

DESCRIPTION	CAT NO	APPLICATION	PRIMARY VOLTAGE	SECONDARY VOLTAGE	CIRCUIT BREAKERS	MAX LOAD	CIRCUIT CAPACITY
ADNM Series Class 2 Transformer	ADNM-60-1-5-12-DIN	Indoor / Outdoor	100-277V AC 50/60 HZ	12V DC	1	60W	5A
	ADNM-80-1-5-12-DIN				1	60W	5A
	ADNM-150-2-5-12-DIN				2	2x60W	2x5A
	ADNM-240-3-5-12-DIN				3	3x60W	3x5A
	ADNM-320-4-5-12-DIN				4	4x60W	4x5A

ADNM - DMX MULTI ADDRESS

DESCRIPTION	CAT NO	APPLICATION	PRIMARY VOLTAGE	SECONDARY VOLTAGE	CIRCUIT BREAKERS	MAX LOAD	CIRCUIT CAPACITY
ADNM Series Class 2 Transformer	ADNM-150-2-5-12-DIN-2	Indoor / Damp	100-277V AC 50/60 Hz	12V DC	2	2x60W	5A
	ADNM-240-3-5-12-din-3				3	3x60W	3x5A

INFINITY - MLV / ELV / 0-10V / TRIAC

DESCRIPTION	CAT NO	APPLICATION	PRIMARY VOLTAGE	SECONDARY VOLTAGE	CIRCUIT BREAKERS	MAX LOAD	MIN LOAD	CIRCUIT CAPACITY
Infinity Series Class 2 Transformer	INF-J-30-1-2.5-12	Indoor / Outdoor	100 - 277V AC	12V DC	1	30W	3W	2.5A
	INF-J-60-1-5-12				1	60W	6W	5A
	INF-J-180-3-5-12				3	3x60W	3x6W	3x5A
	INF-J-300-5-5-12				5	5x60W	5x6W	5x5A

Dimmers

DIMMING - 0-10V

DESCRIPTION	CAT NO	APPLICATION	INPUT VOLTAGE	OUTPUT VOLTAGE	MAX LOAD
0-10V Dimmer	DIM-LD-010	Indoor	12V/24V DC	12V/24V DC	30 mA max. output (sink only)

DIMMING - MLV

DESCRIPTION	CAT NO	APPLICATION	INPUT VOLTAGE	OUTPUT VOLTAGE	MAX LOAD
MLV Dimmer	N-600	Indoor	120V AC	120V AC	450W
	N-1000				800W
	N-1500				1200W
	D-600				450W
	M-600				450W
	M-1000				800W

DIMMING - ELV

DESCRIPTION	CAT NO	APPLICATION	INPUT VOLTAGE	OUTPUT VOLTAGE	MAX LOAD
ELV Dimmer	ME-600	Indoor	120V AC	120V AC	450W
	DE-300				300W

TwoTone Bullnose & Accessories

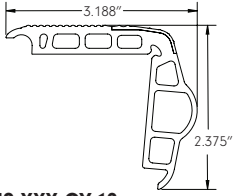

BNS-XXX-GY-12
XXX = TT (black/gray), **TT2** (black/2"gray), **SC** (solid gray)
 TwoTone Bullnose, 12' length

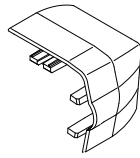

BNS-TT-EC-X
X = L (left side), **R** (right side)
 Bullnose Overlap End Caps, black

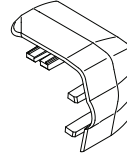

BNS-CC-TT-EC-X
X = L (left side), **R** (right side)
 Bullnose Carpet to Carpet End Caps, black

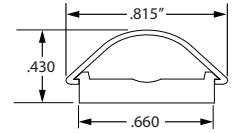

BS-CC-8
 Wall Wireway, 8' black base & conduit cover

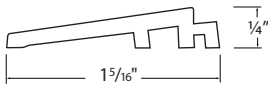

BNS-TT-R-12
 Step Reducer, 12' section

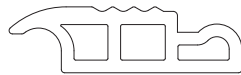

STP-EXTNDR-12
 Bullnose Step Landing Tread Extender, 12'



ADH-MB-75AM-XX
XX = 10 (10.1 oz tubes, 30 per case), **29** (29 oz tubes 12 per case)



ADH-IA-10.2-CA
 End cap clear liquid adhesive, 10.2 oz tubes sold individually, 12 per case

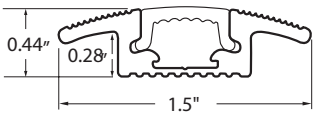

WW-XX-XX-8
XX = CC (Carpet to Carpet base), **CW** (Carpet to Wall base)
XX = BK (black lense), **GY** (gray lense)
 Base and Cover Combo, 8' length

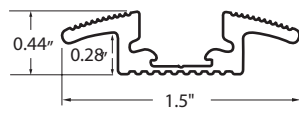

WW-XX-BS-8
XX = CC (Carpet to Carpet), **CW** (Carpet to Wall)
 Base Only, black, 8' length



WW-TC-XX-8
XX = CL (clear) **BK** (black), **BZ** (bronze), **GY** (gray)
 Top Cover Wire Way lens, 8' length

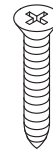

TM-3/16
 Concrete Screw 3/16" x 1 3/4"

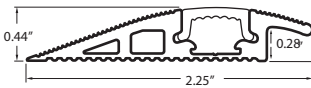

WW-CE-XX-8
XX = BK (black), **GY** (gray)
 Carpet to Edge Base and Cover Combo, 8' length



WW-CE-BS-8
 Base Only, Carpet To Edge, black, 8' length



RONDB-5/32
 Concrete Drill Bit 5/32"